

# Effective Lab Oral Report – Fall 2018

David Hertzog, Eugene V Colla, Virginia Lorenz  
*University of Illinois at Urbana-Champaign*



**We will present some of my slides and many Phys 403 student slides as examples. We can talk about why they are well constructed examples.**

(All remarks about real slides are in these red boxes)

**An eye-catching feature on slide 1**

# This is a technical presentation, so you must develop it as a logical sequence

Sentence title tells what the slide is about ... the rest of the slide supports the assertion

- ✓ ■ What was the goal?
  - ◆ What physics did you address?
  - ◆ What technology?
  - ◆ Define your special vocabulary here
- ✓ ■ What did you actually do?
  - ◆ Apparatus / Procedures / Raw Data
- ✗ ■ What are your results?
  - ◆ Polished graphs, proofs, numerical findings
  - ◆ Principal difficulties and uncertainties
- ✗ ■ Conclusions

Fonts matter

Arial

Comic Sans

Times

Courier

# Presentation components and grading scale.

- ✓ Title slide
- ✓ Science introduction
- ✓ Procedure
- ✓ Results. Analysis. Data.
- ✓ Conclusions. Suggestions etc.

CRITERIA	score
Scientific background, goal and motivation were clearly presented (5)	
Research activities were clearly presented (10)	
Results were clearly presented (10)	
Scientifically accurate figures and explanations (10)	
Technical aspects: complete title slide, good balance of text and figures, good quality figures, appropriate citations, correct spelling, etc. (10)	
Oral delivery was balanced between partners, was not too slow or too fast, and was understandable (5)	
Final Totals (50)	

Title

# OPTICAL STUDY OF FERROELECTRIC POTASSIUM DIDEUTERIUM PHOSPHATE (DKDP)

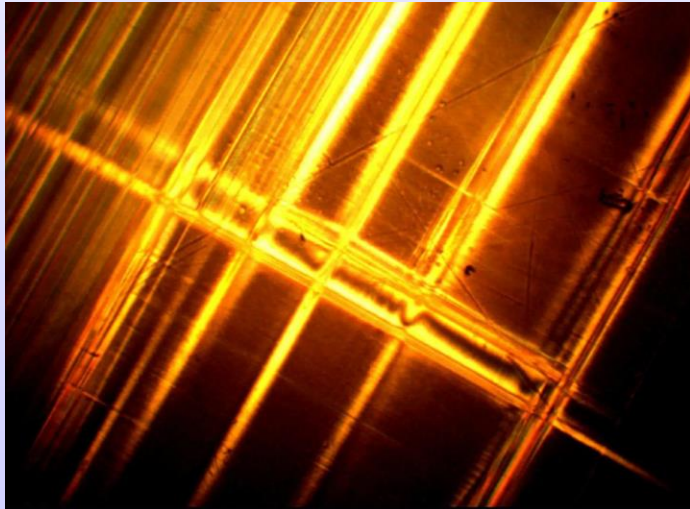

Author name

Student name

2/19/13

Date

Physics 403, Fall 2013  
University of Illinois at Urbana-Champaign

Affiliation

# Phase transition of Helium 4

- Below  $T_\lambda = 2.17$  K, helium exists in mixture of superfluid and normal liquid helium.

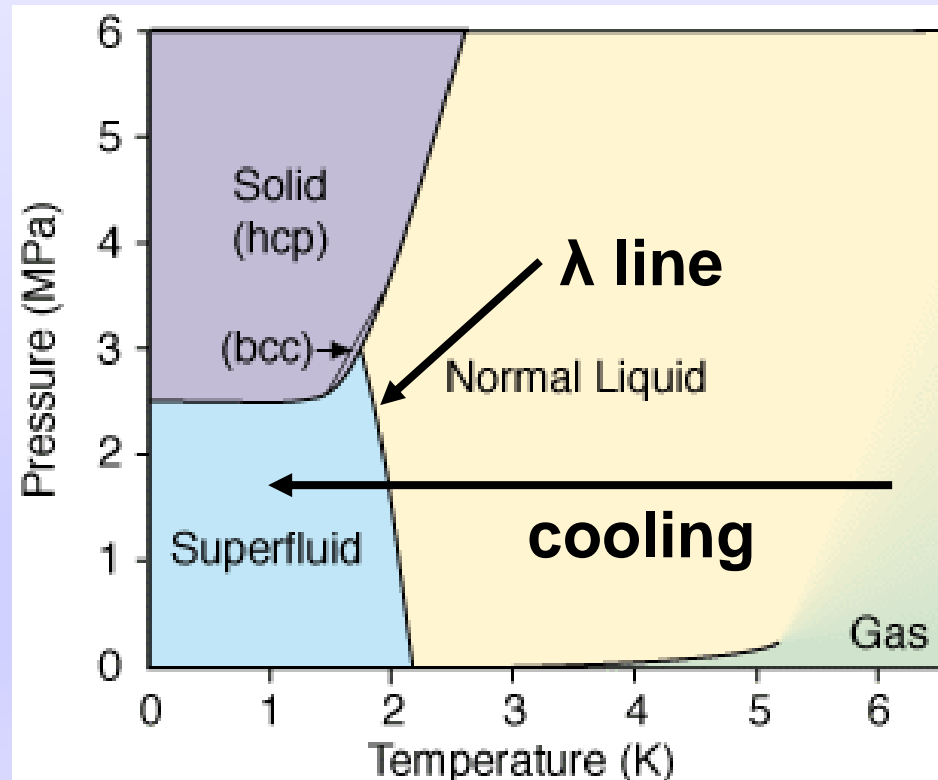

The muon lifetime leads to the most precise determination of the Fermi constant, and gives the weak interaction strength

- The relation is

measure this  $\rightarrow$  
$$\frac{1}{\tau} \propto G_F^2 (1 + \delta)$$

- *MuLan* aims to determine  $\tau_\mu$  to 1 part per million precision, which requires:

- ◆  $10^{12}$  muon decays
- ◆ A muon beam of several MHz
- ◆ A time-structured (chopped) beam

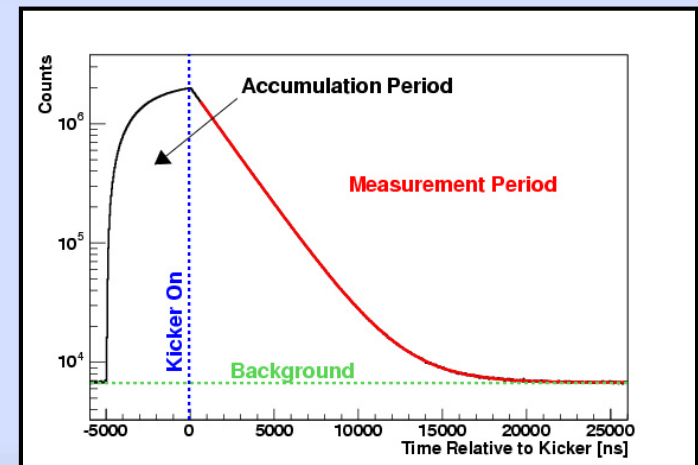

# What happen if they are struck by pulses ?

A pulse or a series of pulses is used to change the net magnetization of system. Pulsed NMR!

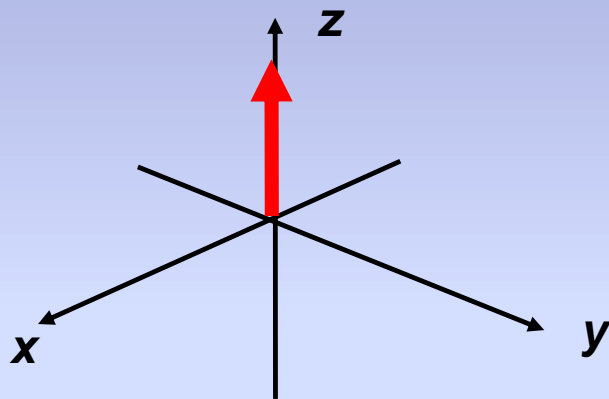
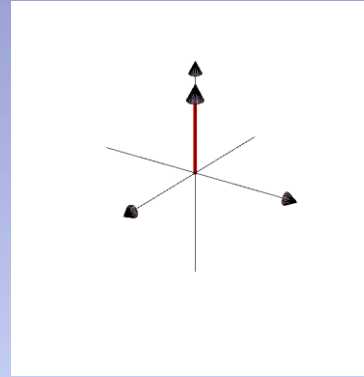

90° Pulse

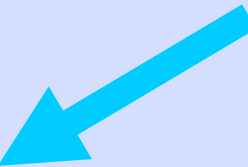
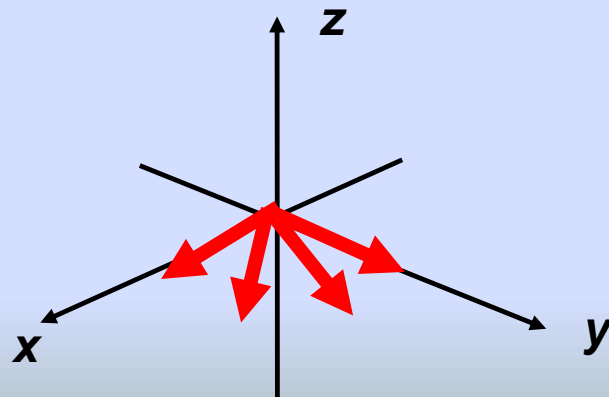
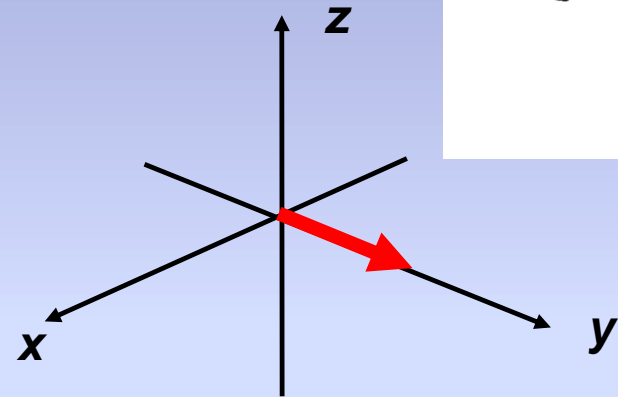
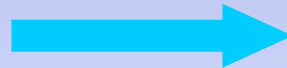

?

$$M(t) = M_0 e^{-\frac{t}{T_2}}$$

# What happens to a nucleus in a magnetic field ?

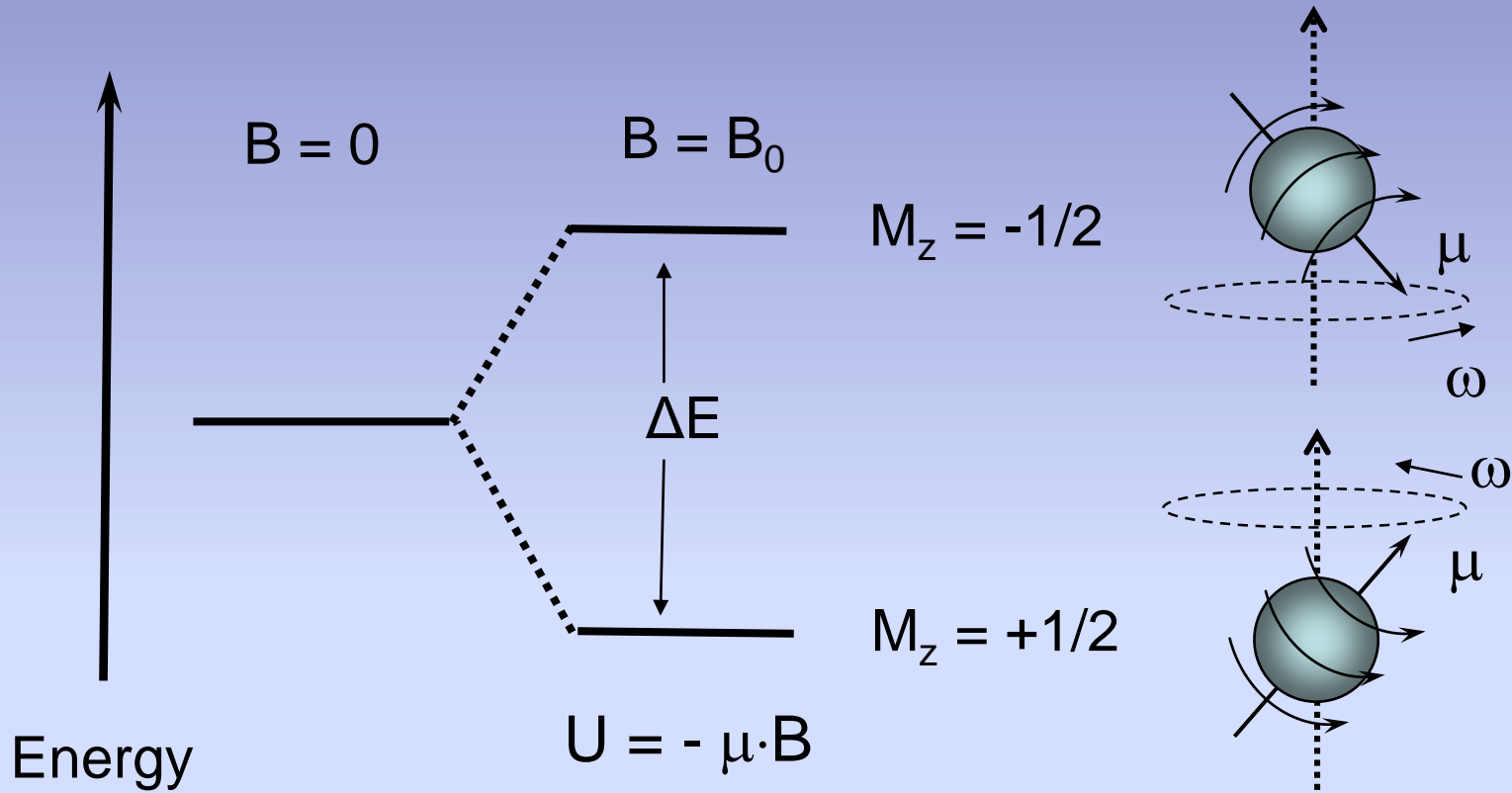

(Courtesy of Bishop. K)

$$\Delta E = \gamma \cdot \hbar \cdot B_0 = \hbar \omega_0 \rightarrow \text{Larmor frequency!}$$



# Phase Transition in BaTiO<sub>3</sub>

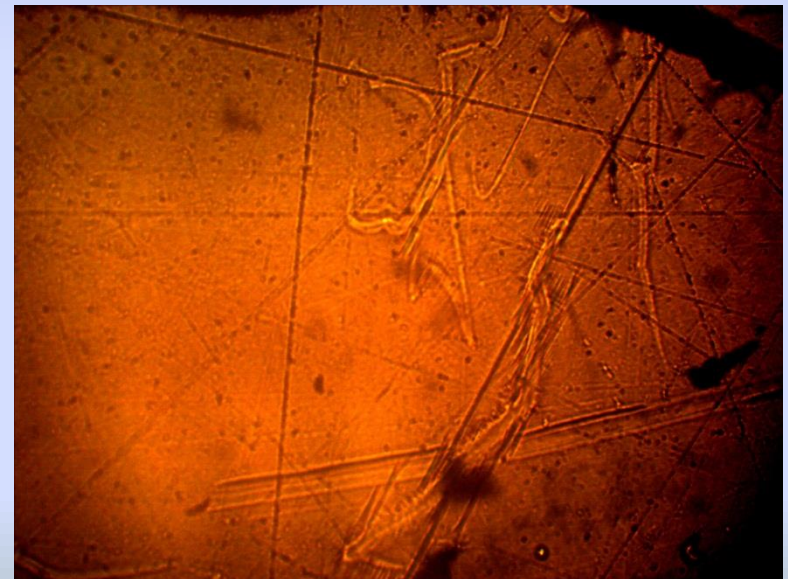
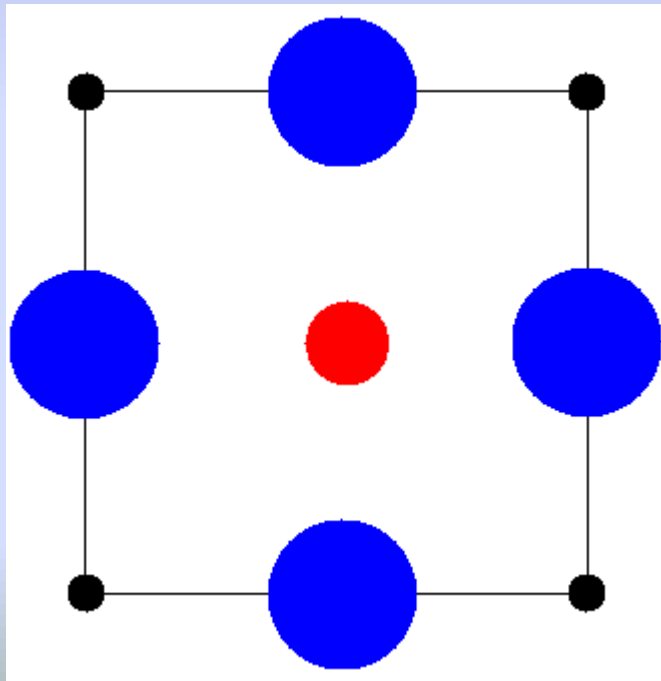
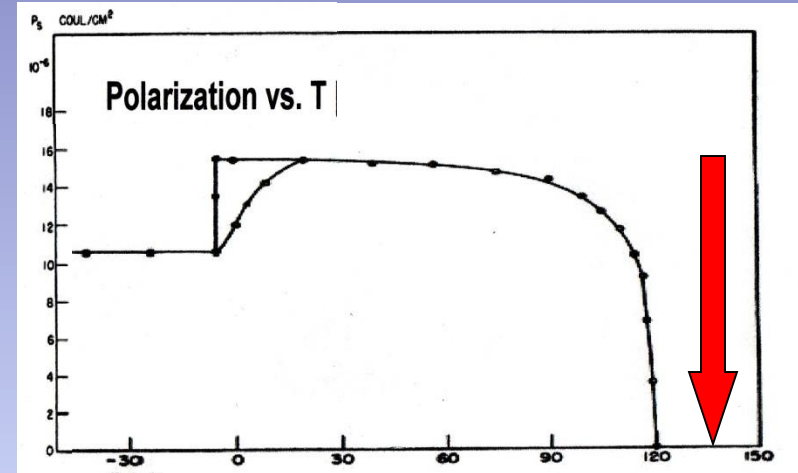
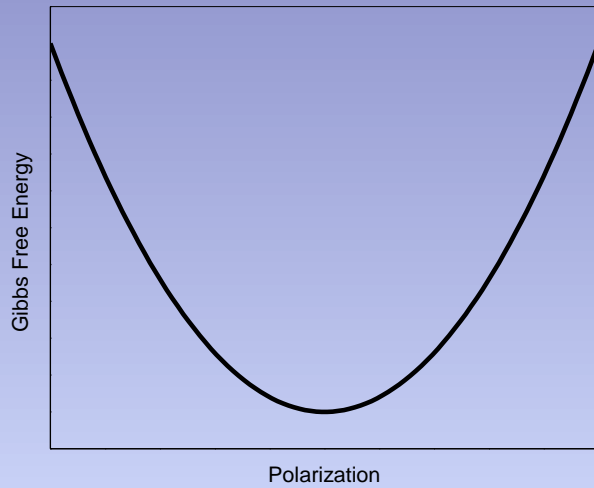

# Phase Transition in BaTiO<sub>3</sub>

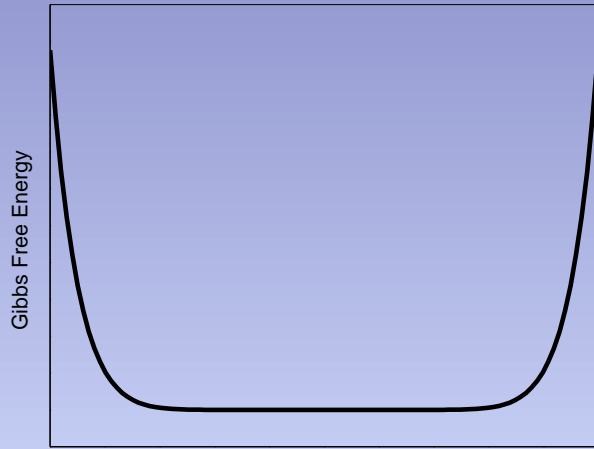

Polarization

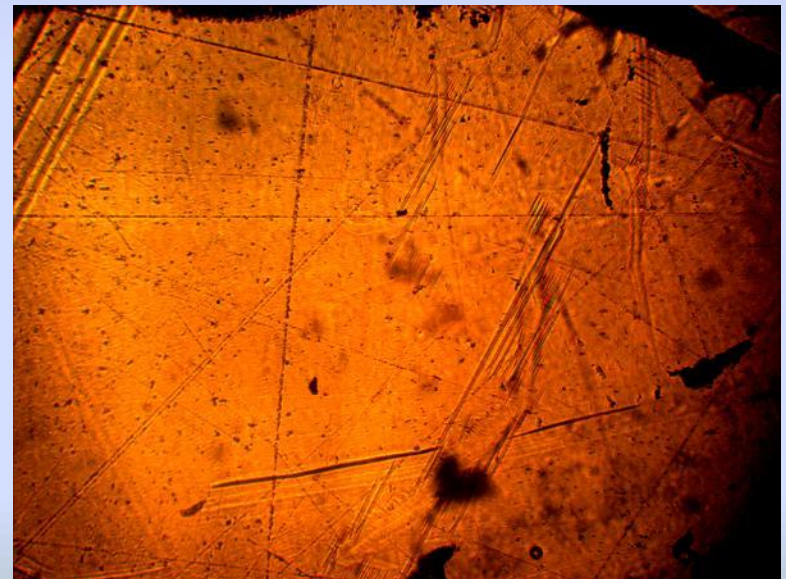
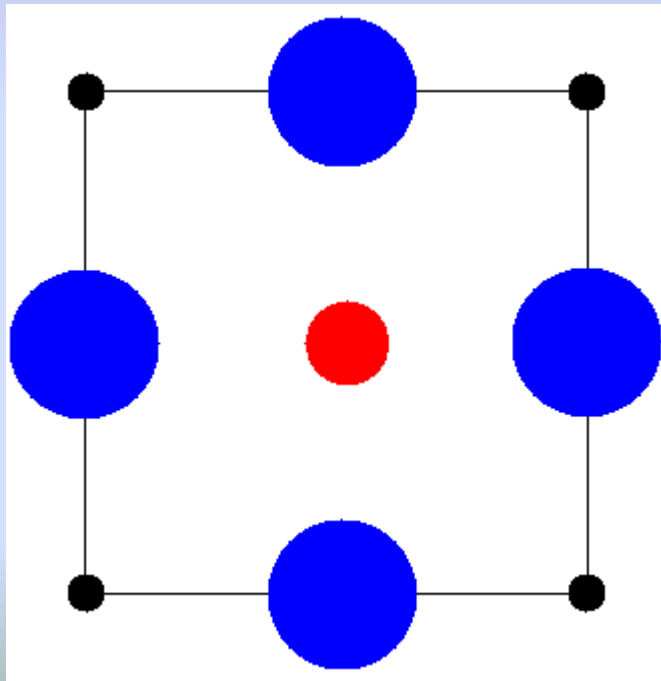
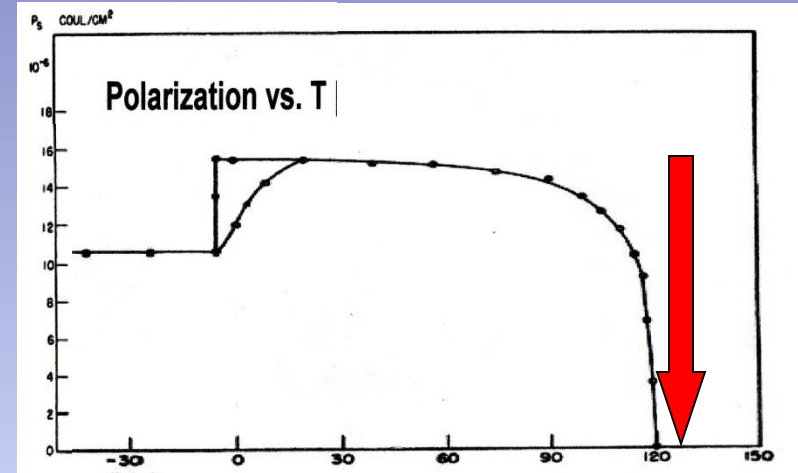

# Phase Transition in BaTiO<sub>3</sub>

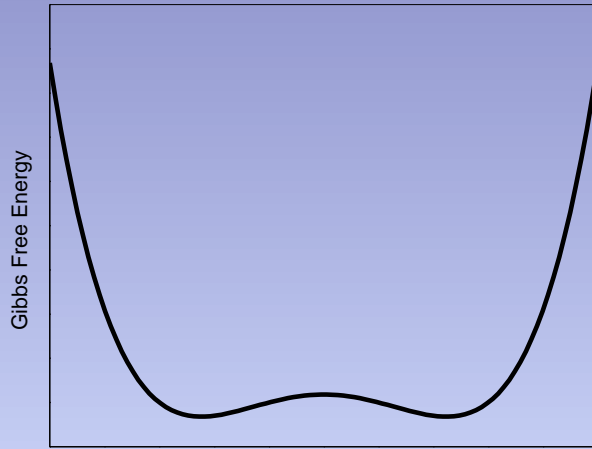

Polarization

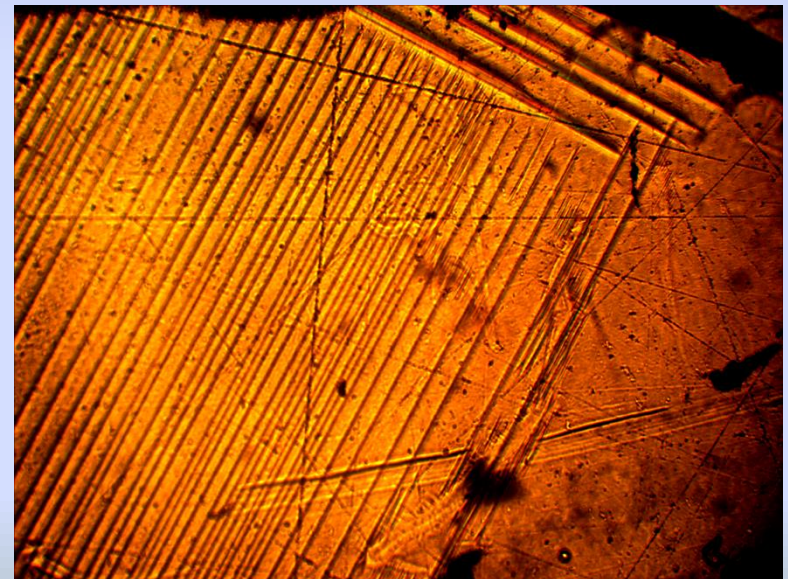
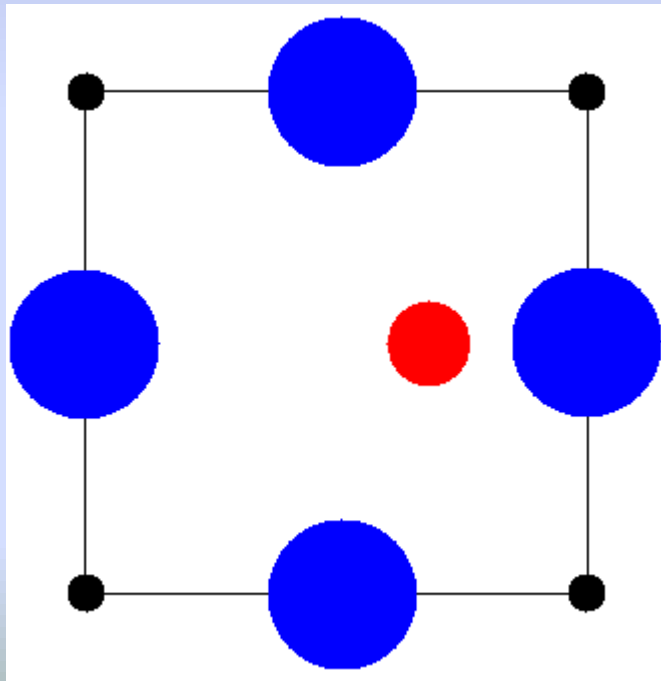
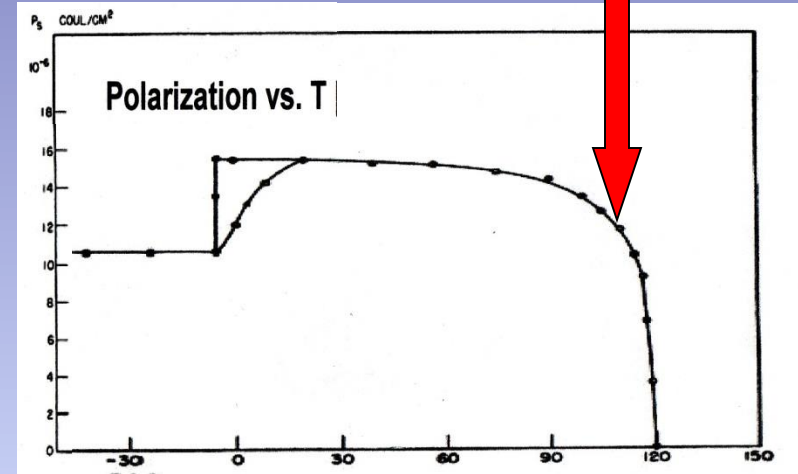

# Phase Transition in BaTiO<sub>3</sub>

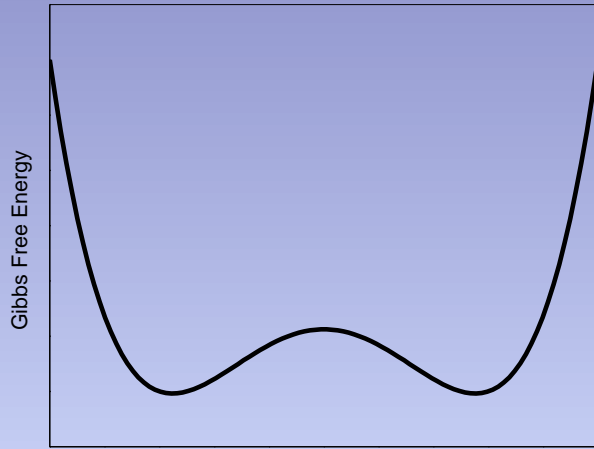

Polarization

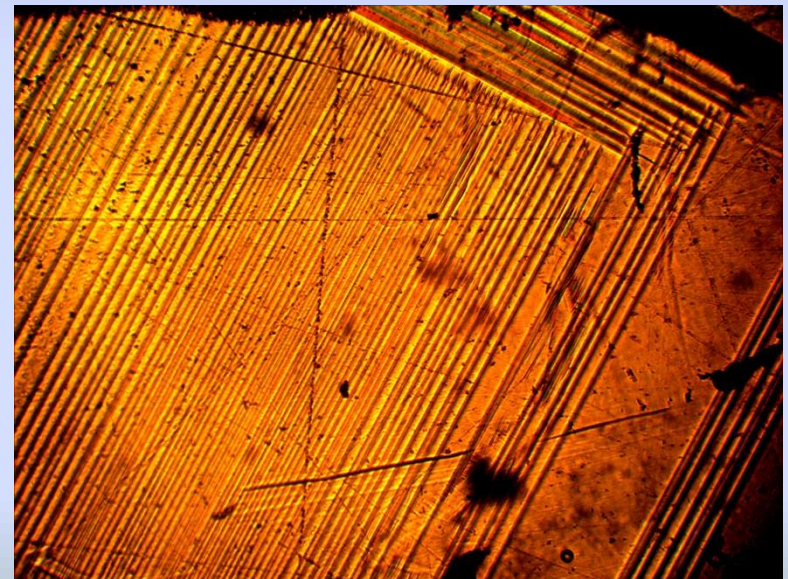
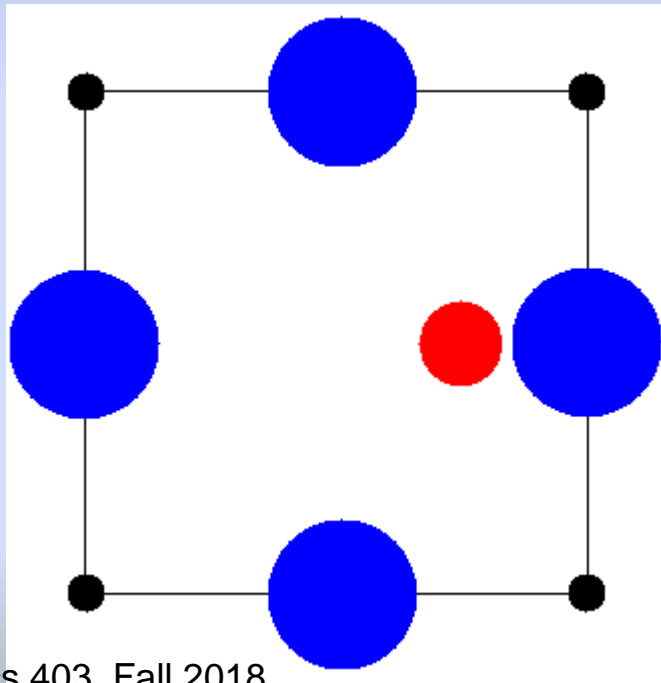
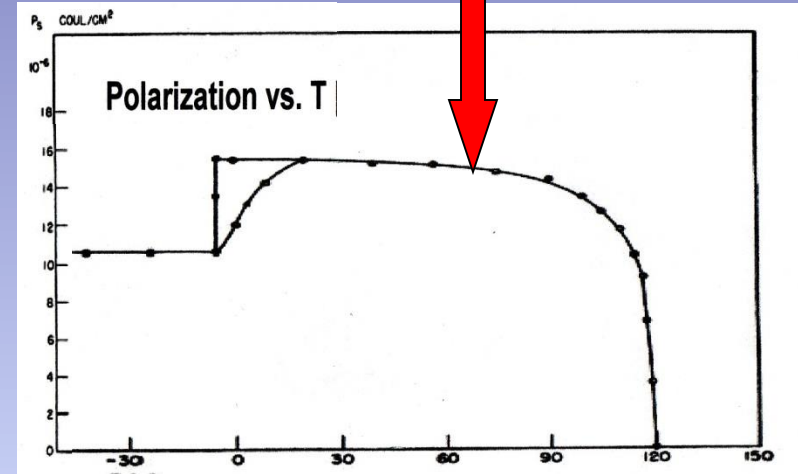

# ASIDE: Keep equations selective and informative

- What can an audience grasp in 'real time'?
  - ◆ If they already know it, then they know it
  - ◆ If they don't know it, they usually have to study it term by term
- Take a simpler approach
  - ◆ Substitute proportionalities for equalities ?
    - Can eliminates uninteresting constants
    - Can emphasize relationship of variables
  - ◆ Substitute words for blocks of standard terms?

$$\frac{1}{\tau} = \frac{G_F^2 m_\mu^5}{192\pi^3} (1 + \delta)$$
$$\frac{1}{\tau} \propto G_F^2 (1 + \delta)$$

$$\Gamma \propto (\text{phase space}) \times M_{ij}$$

Set them off attractively

- ◆ Use builds and arrows to walk audience thru (see example)

# Excitation and fluorescence signal convoluted together

observed signal  $\rightarrow$   $F(t) \propto \int_0^t E(t') F_\delta(t-t') dt'$

excitation signal  $\rightarrow$   $E(t')$

simple fluorescence response (exponential)  $\rightarrow$   $F_\delta(t-t')$

- Excitation as sinusoid is simplest:

$$E(t) = E_0 + 2E_1 \cos(\omega t)$$

- Generalized through Fourier analysis
  - All periodic function can be expanded as sum of sinusoids

**Show the equipment IF it helps explain your steps – not because you love it**

- **Photographs give scale and reality – but you add labels**
- **Schematics provide concept**
- **Icons strip away unnecessary details**
- **All of these techniques can be useful**

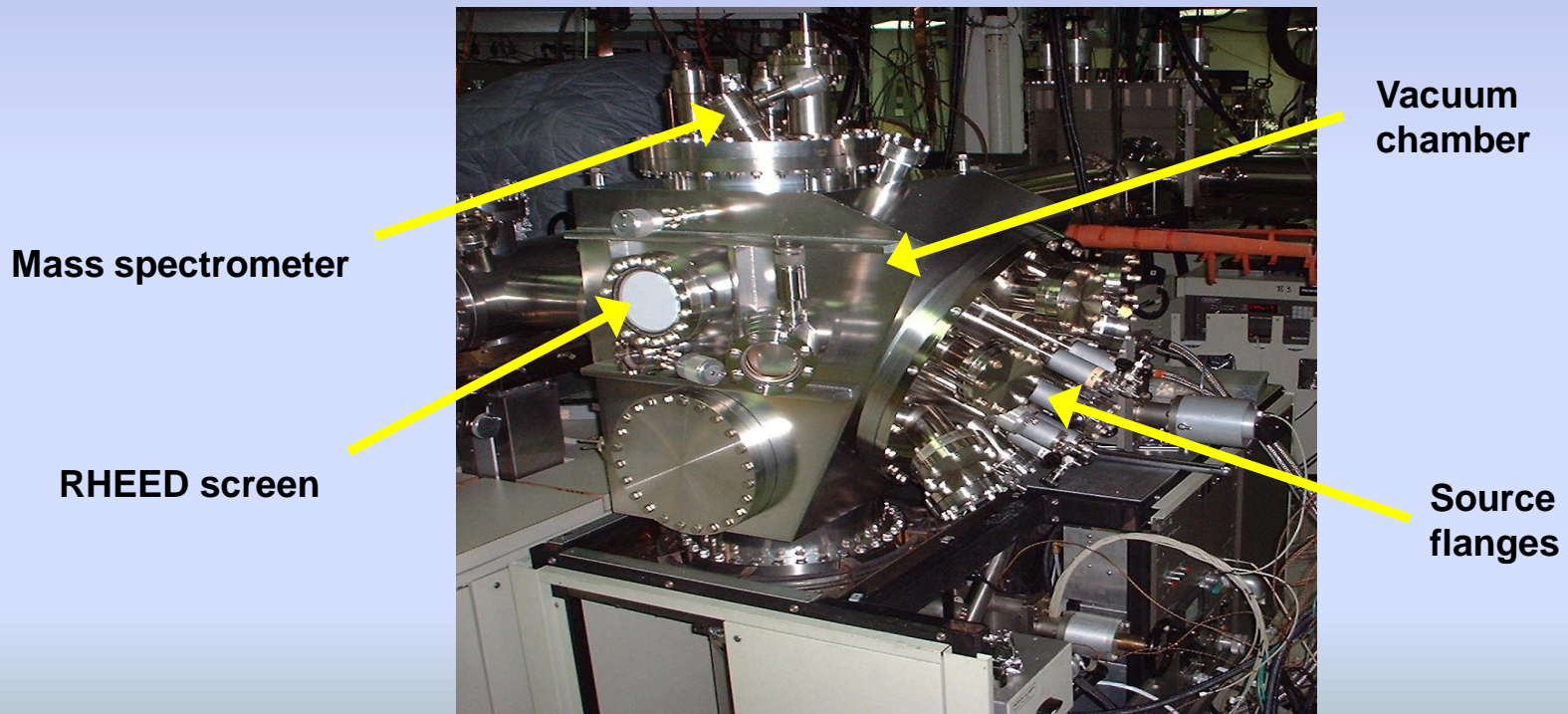

Everybody loves an optical bench, but unless you map out the elements and the beam paths, it doesn't mean much

# Experimental Apparatus

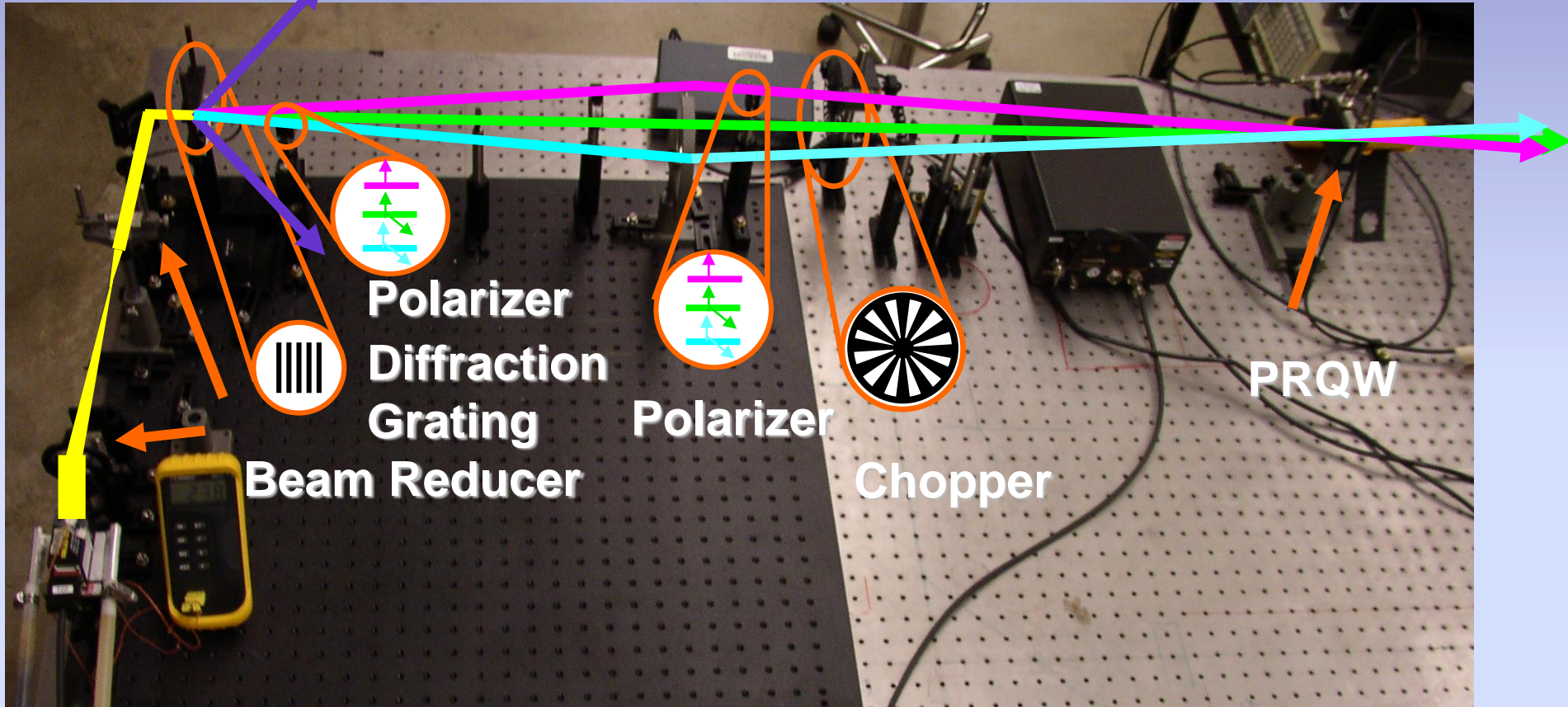



An example of image which is nice but does not help too much



# Magnetic Field Calibration

■ The magnetic field from the Earth and other residual magnetic fields is minimized by rotating the stand and adjusting the vertical field coils to minimize the zero field peak width.

■ With the main field coils off, the sweep field is applied to determine the center of the zero field resonance (was found to be at 0.251A; using the geometry of the coils, this corresponds to 0.151 gauss).

■ RF field is adjusted to provide maximum transition probability.

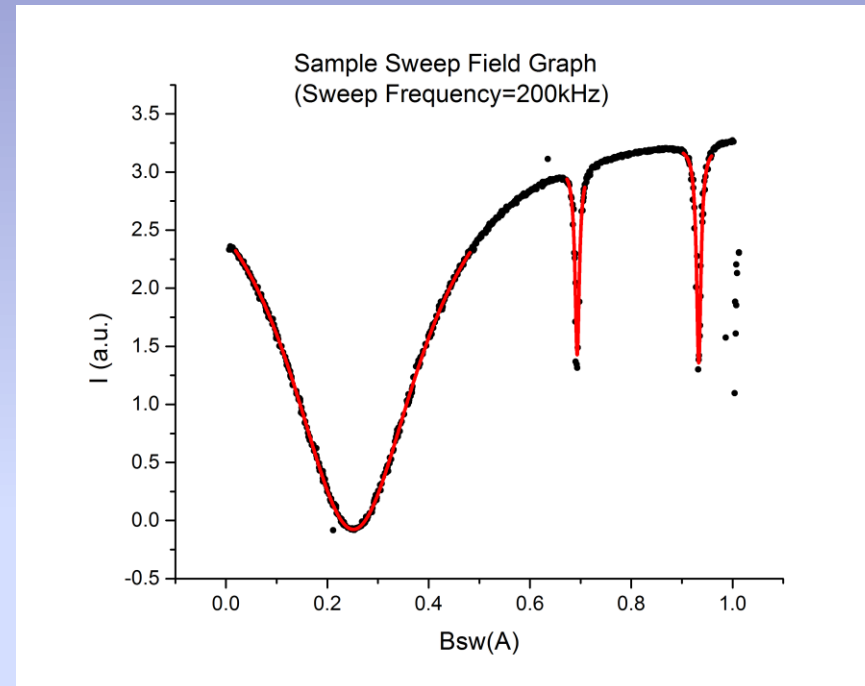

Too many words on slide

# Setup diagrams, apparatus, measuring idea...

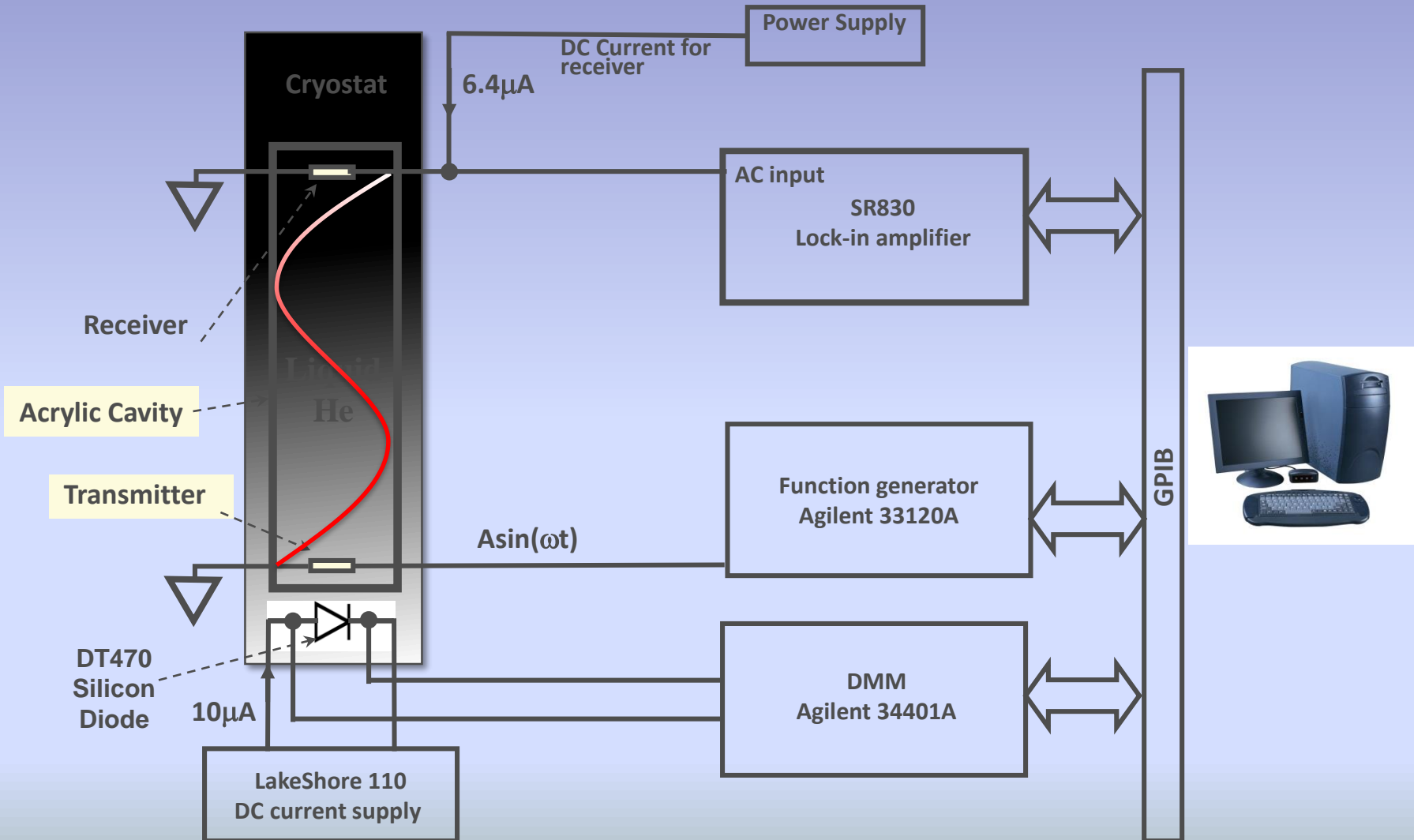

# Samples: preparation, configuration etc.

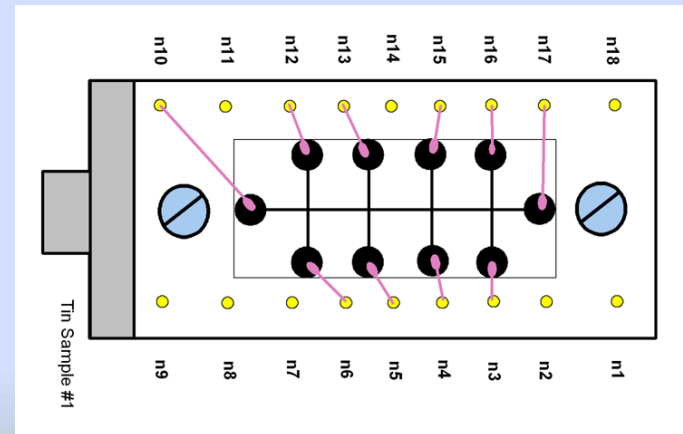
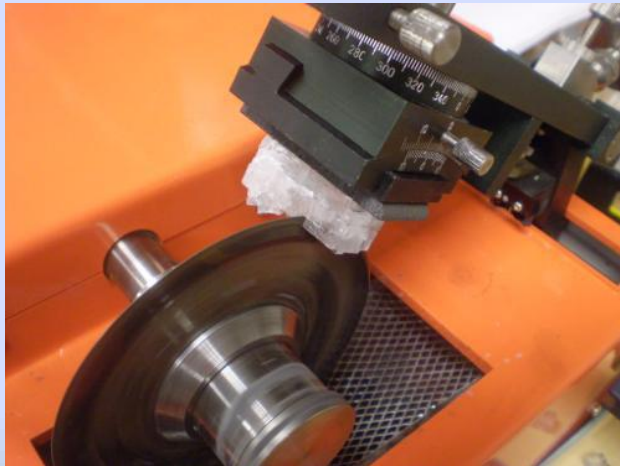
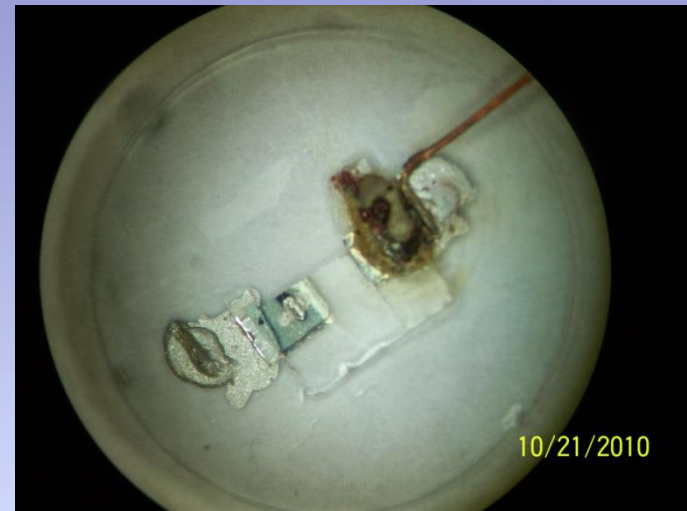
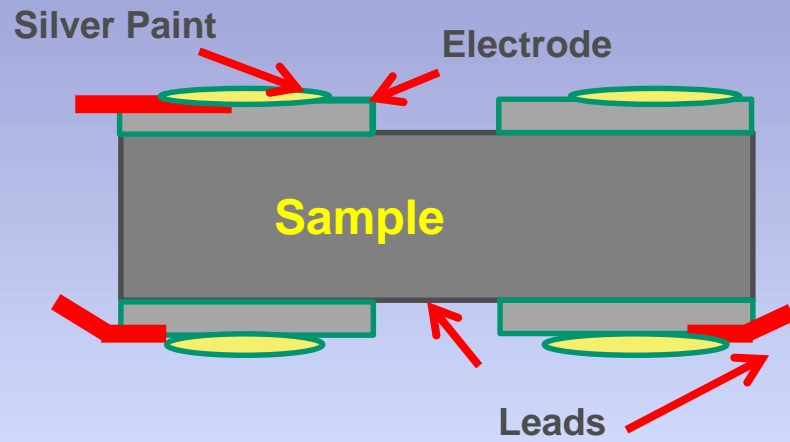

# Setup of Source and Detectors

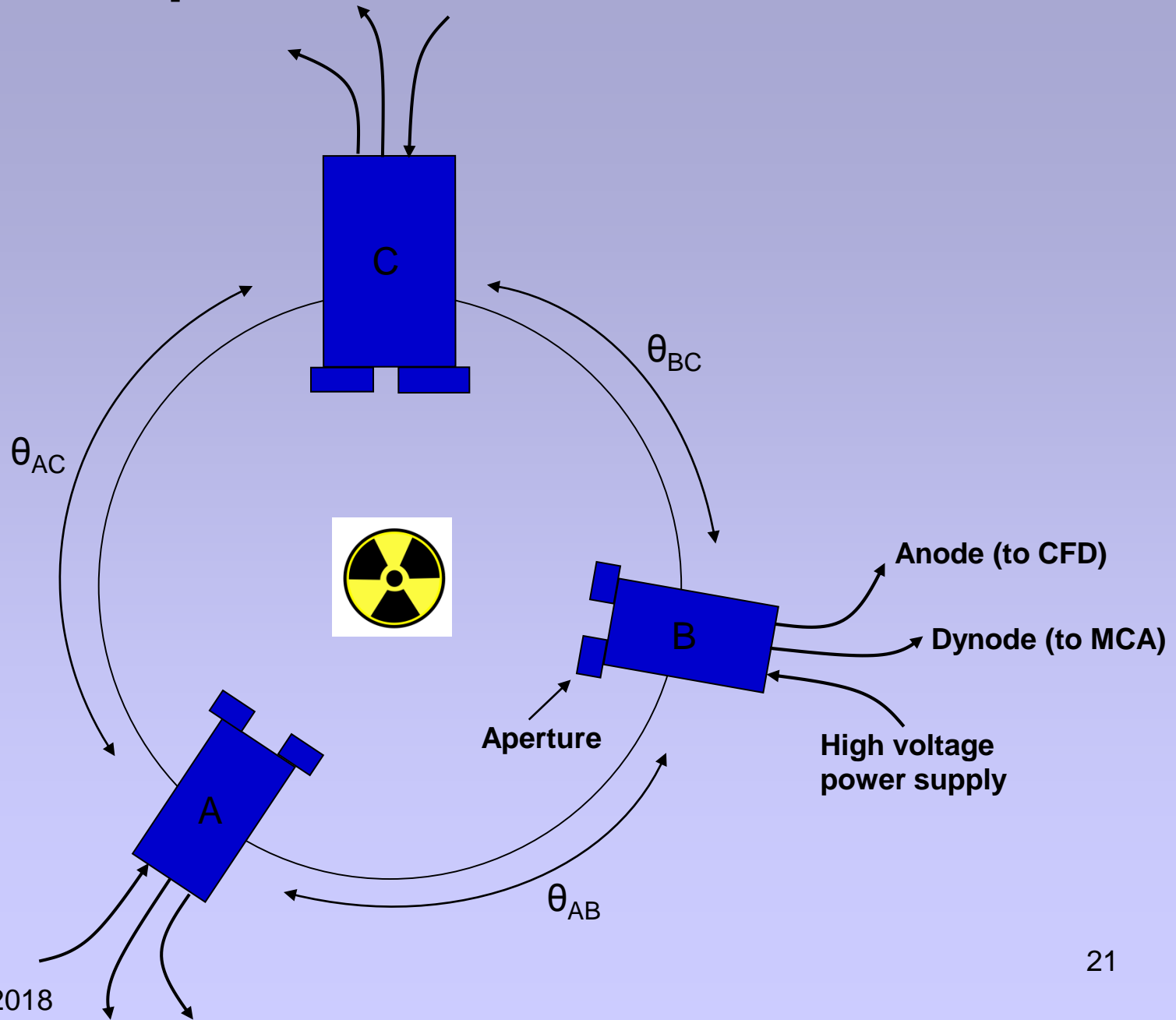

# Results

Raw tunneling data

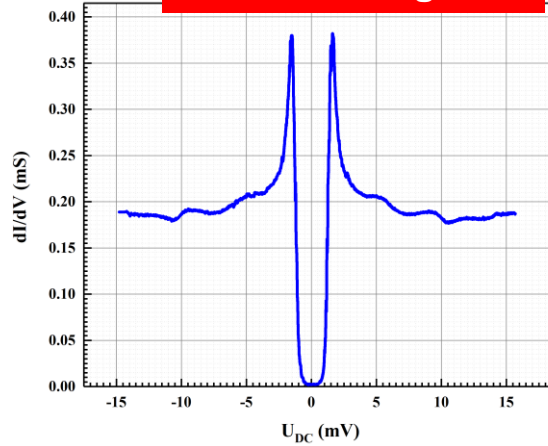

Energy Gap vs. Reduced Temperature

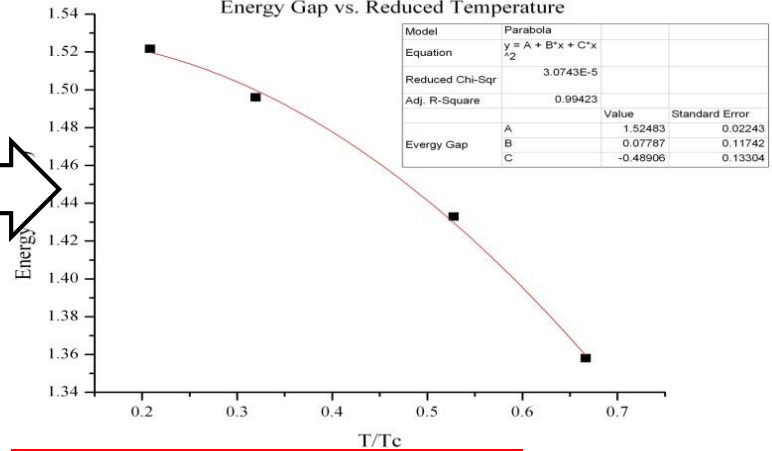

Energy gap derived from tunneling conductivity

Count Rate vs. Pressure (Argon)

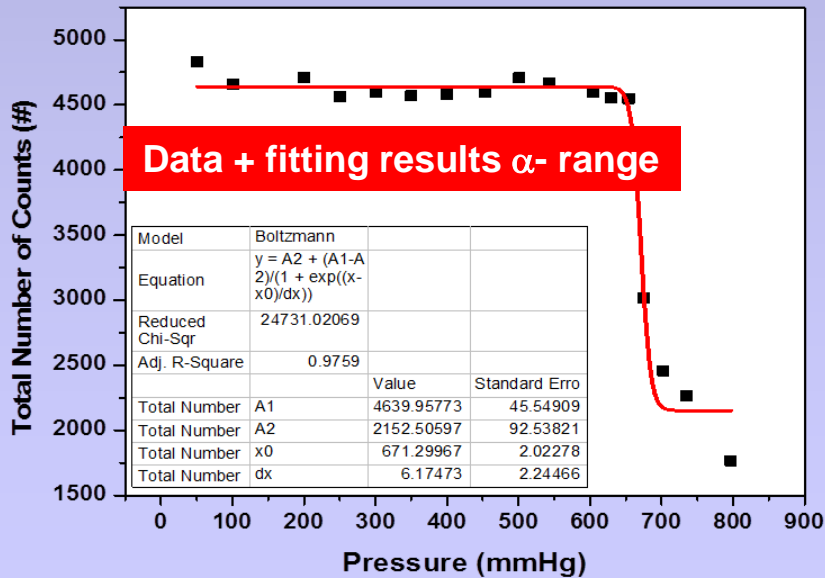

Data + fitting results  $\alpha$ -range

Data + fitting results fluorescence

$\tau_M = 3.9 \pm 0.14 \text{ ms}$

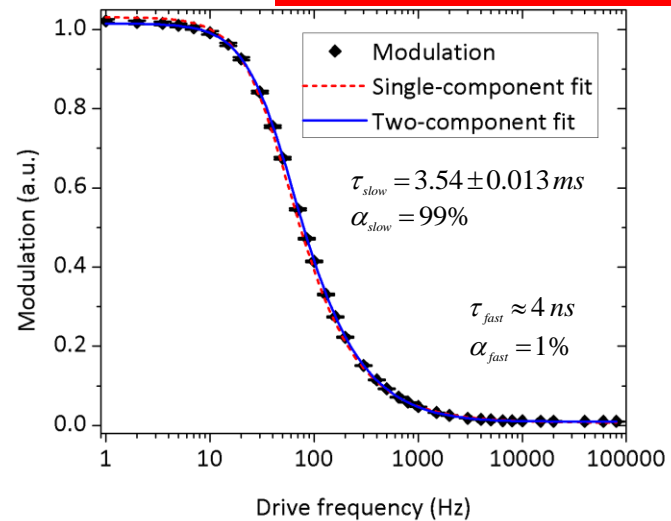

## Difference in Up-Down (unnormalized)

$$\text{Fit equation } Ne^{\frac{-t}{\tau}} \left( 1 + \alpha \cos(\omega t + \delta) \right)$$

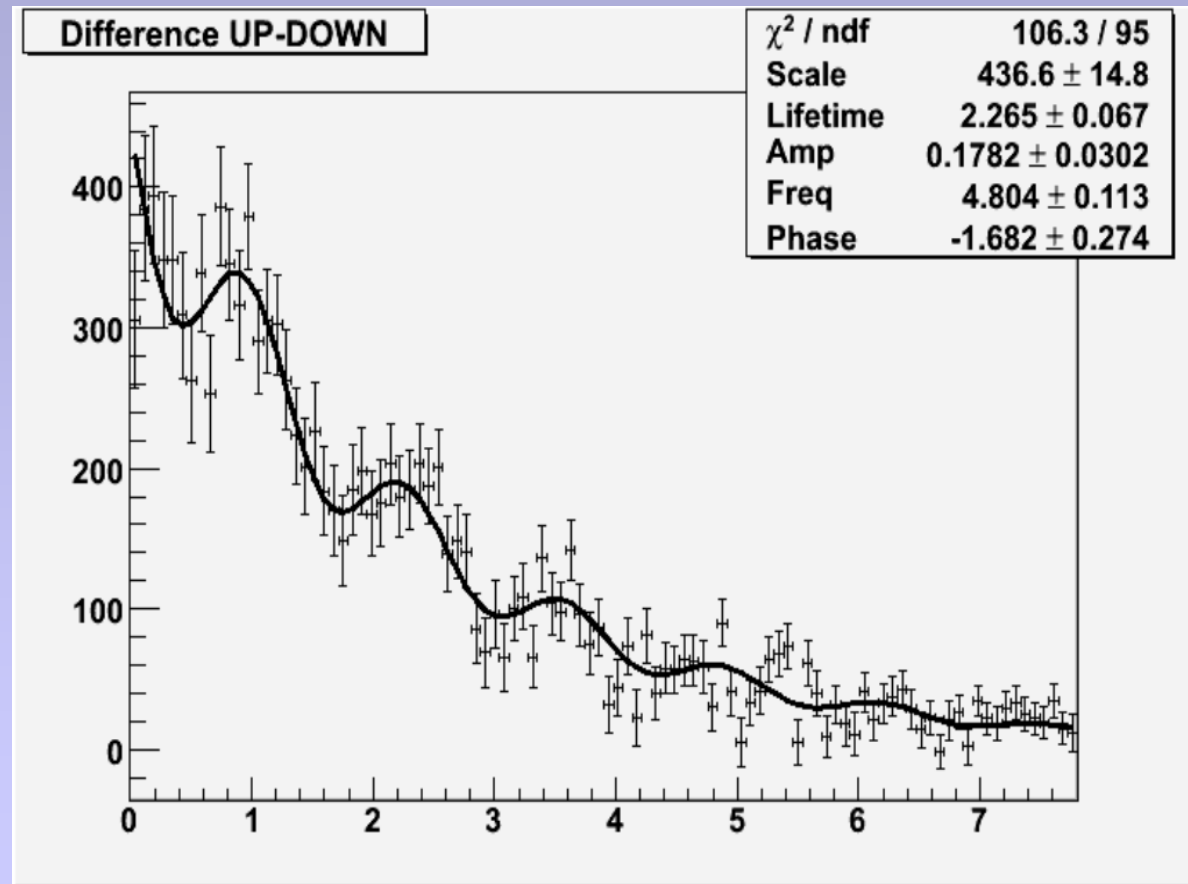

Courtesy Samuel  
Homiller and Pakpoom  
Buabthong Fall 2013

## Difference in Up-Down (normalized)

$$\text{Fit equation } Ne^{\frac{-t}{\tau}} \left( 1 + \alpha \cos(\omega t + \delta) \right)$$

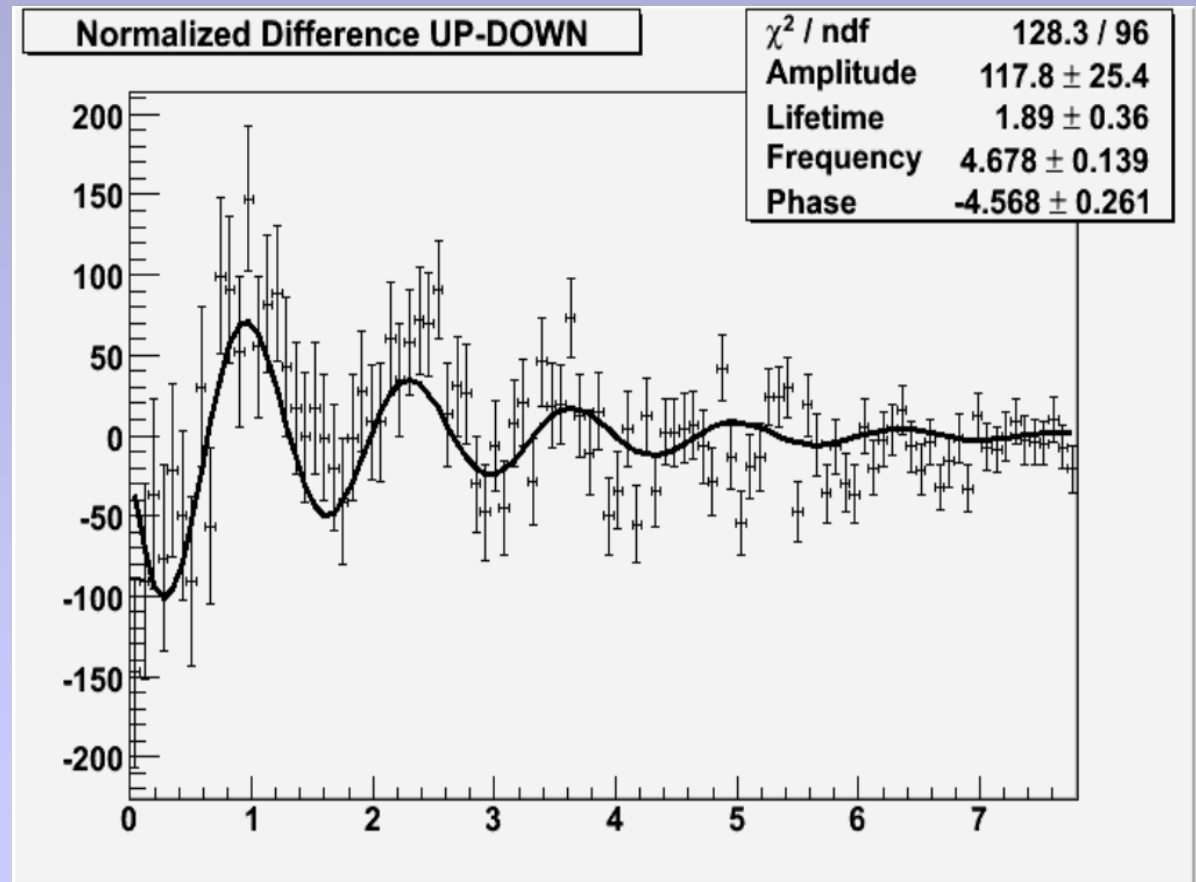

Courtesy Samuel  
Homiller and Pakpoom  
Buabthong Fall 2013



# Results – witnessing a mystery?

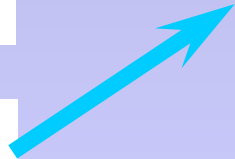
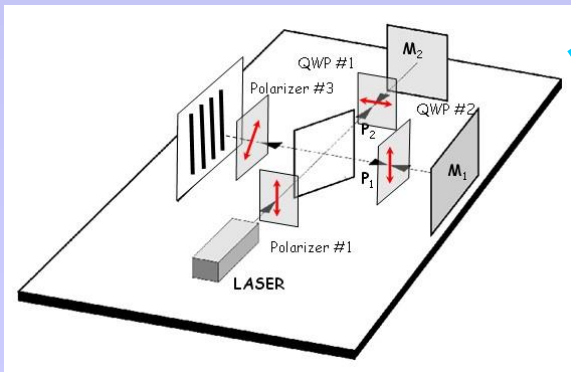
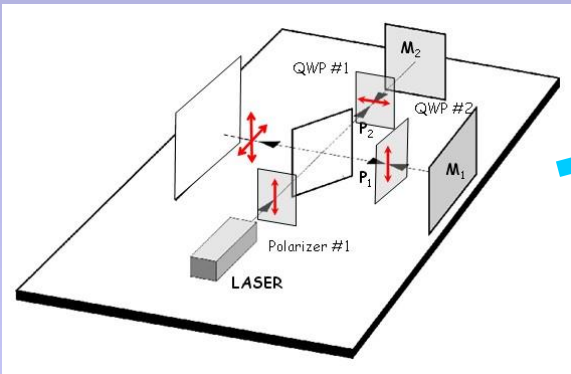
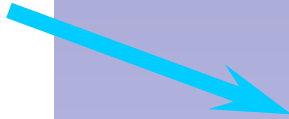
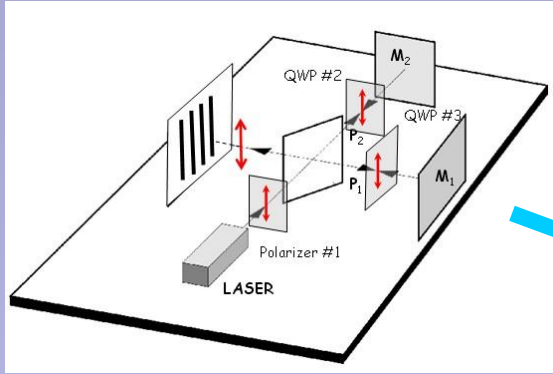

# Presenting data is your most important and challenging task

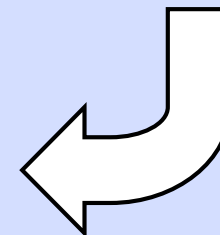
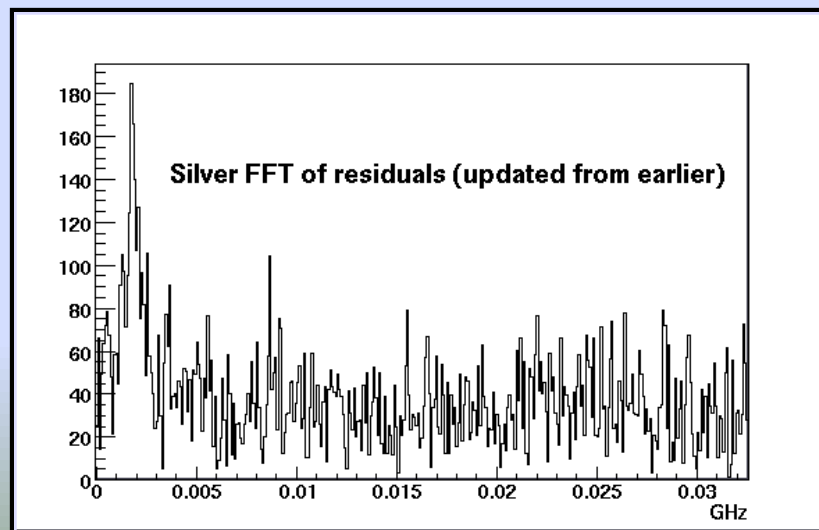
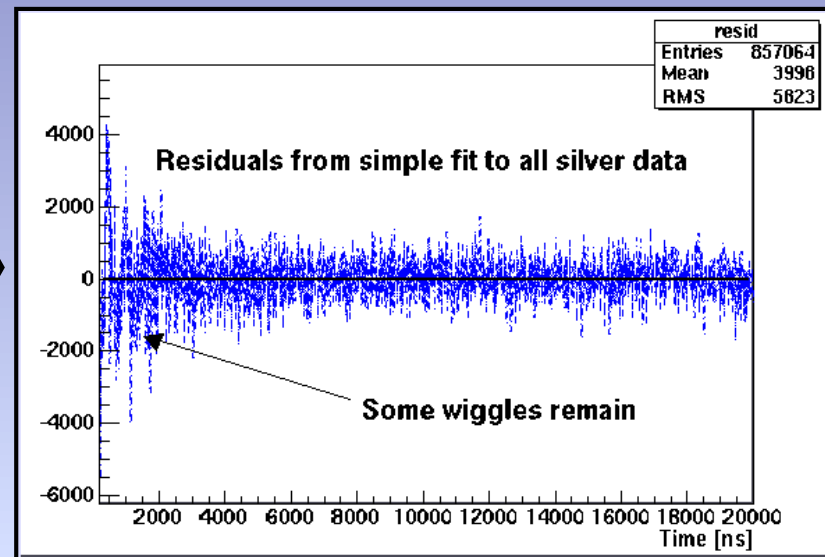
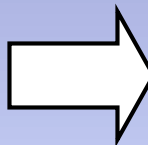
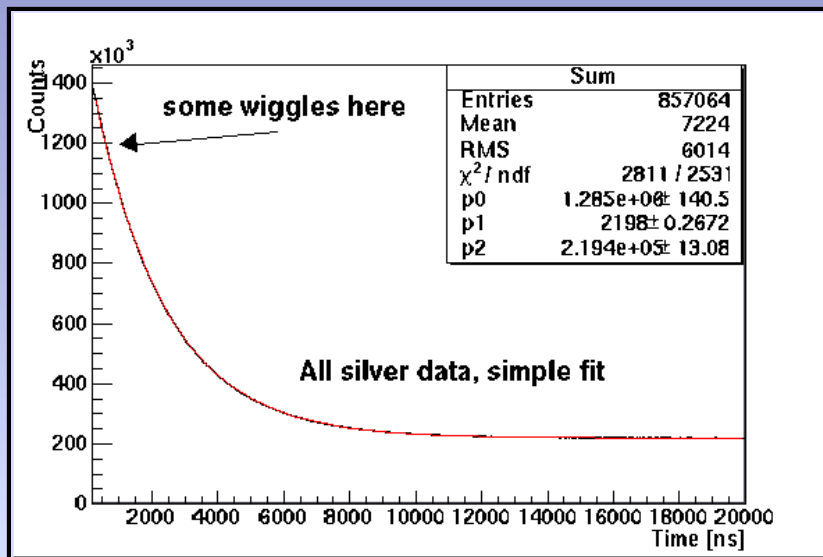

# Fitting to the Curie-Weiss law

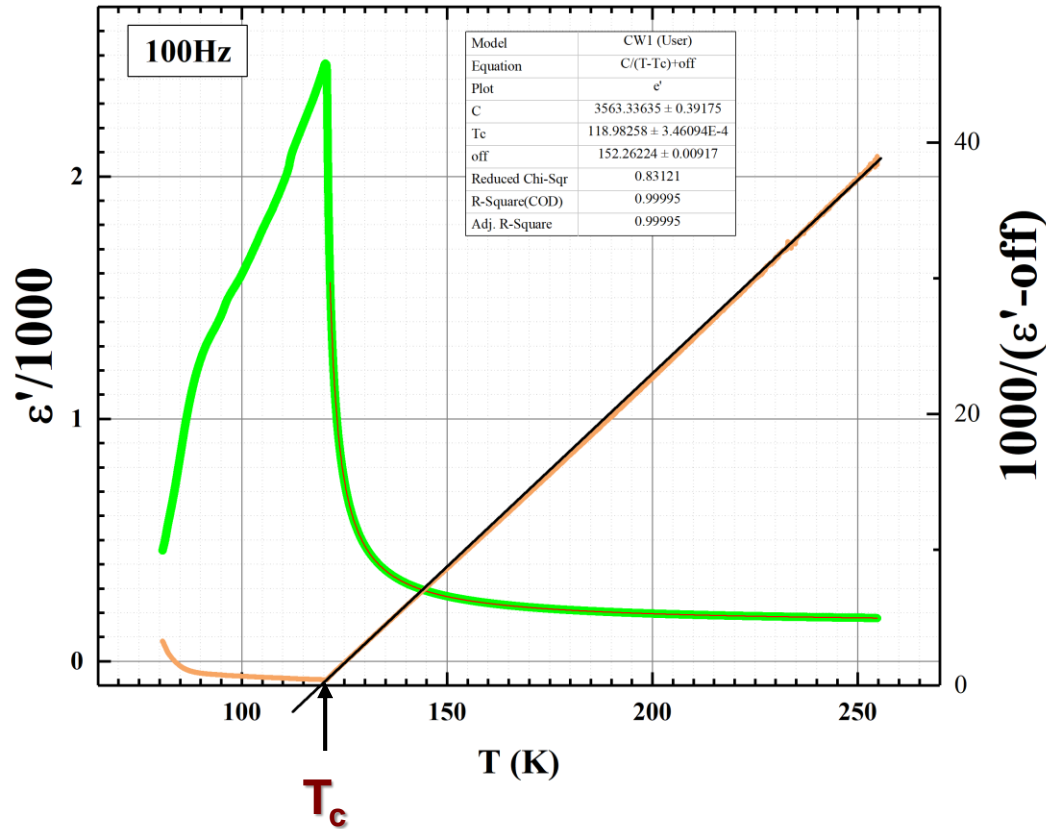

$$\epsilon' = \frac{C}{T - T_C} + off$$

$$C = 3563.3 \pm 0.4 \text{ K}$$

$$T_C = 118.9825 \pm 0.0003 \text{ K}$$

Courtesy Zongyuan Wang and Arnulf Taylor Su 2017

# AFM of Optical Data Storage Media

**CD**

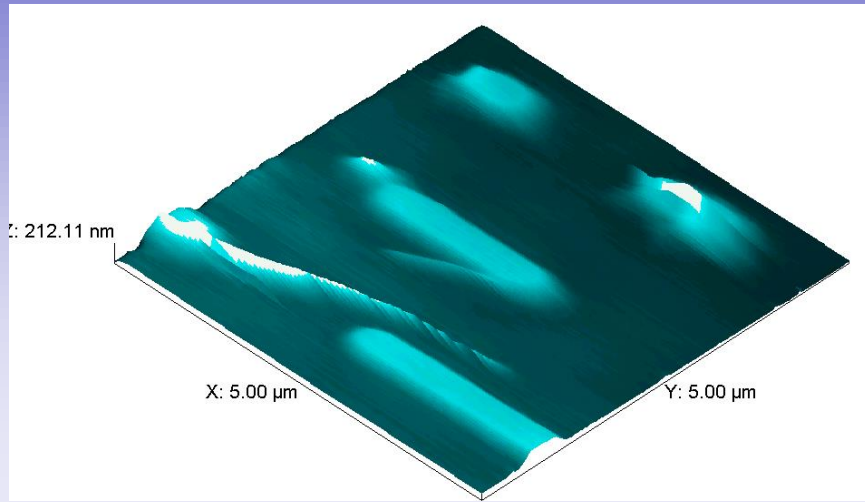

**DVD**

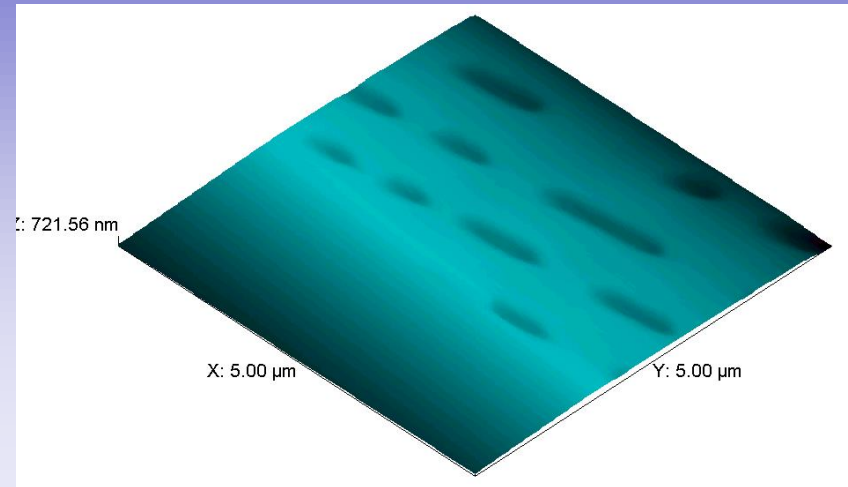

**Blu-Ray**

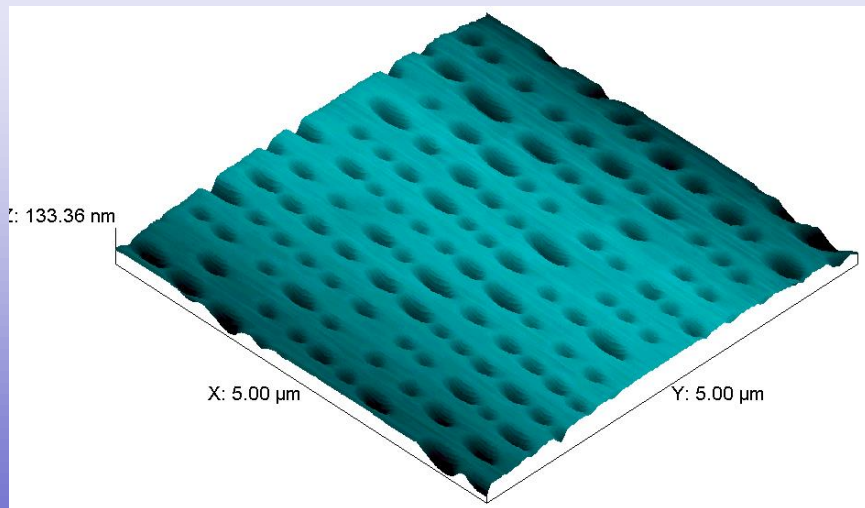

	CD	DVD	Blu-Ray
<b>Mark length</b>	<b>0.99 - 2.96</b>	<b>0.48 - 1.45</b>	<b>0.14 - 0.41</b>
<b>Track pitch</b>	<b>1.63</b>	<b>1.00</b>	<b>0.40</b>
<b>Track width</b>	<b>0.50</b>	<b>0.24</b>	<b>0.15</b>

**Units in  $\mu\text{m}$**

$$V = C \sqrt{\left(\frac{T - T_{offset}}{T_\lambda}\right) \left(1 - \left(\frac{T - T_{offset}}{T_\lambda}\right)^{5.6}\right)}$$

Offset, intrinsic to the experiment

$$C \approx 26$$

$$T_\lambda \approx 2.17$$

$$V = C \left[ \left(\frac{T - T_{offset}}{T_\lambda}\right) \left(1 - \left(\frac{T - T_{offset}}{T_\lambda}\right)^\beta\right)^\gamma \right]$$

Fit to the exponents as well

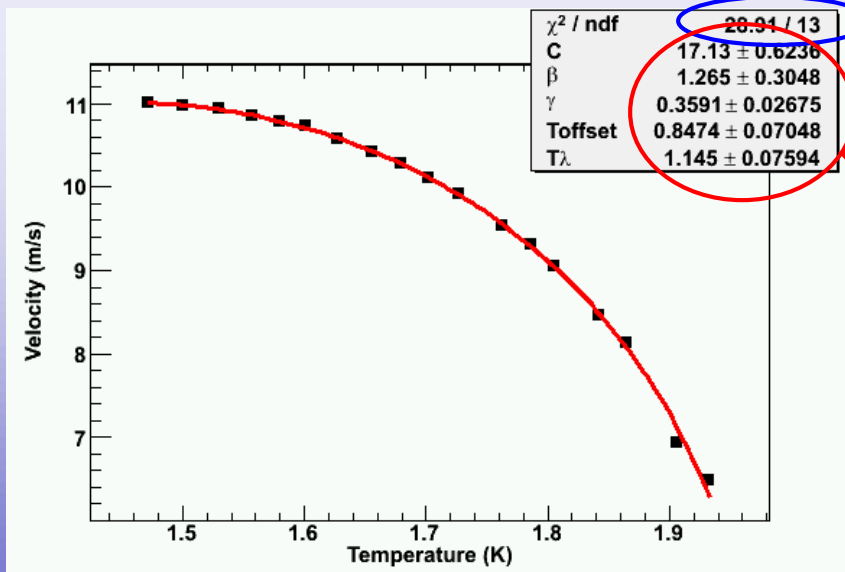

Perform the 5 parameter fit-

The values that are obtained are not very close to the expected values

Also, the fit is not the best

Try to fit the data with this function

$$V = \left( 1 - \frac{T - T_{\text{offset}}}{T_{\lambda}} \right)^{\gamma}$$

The data refuses to fit to this function

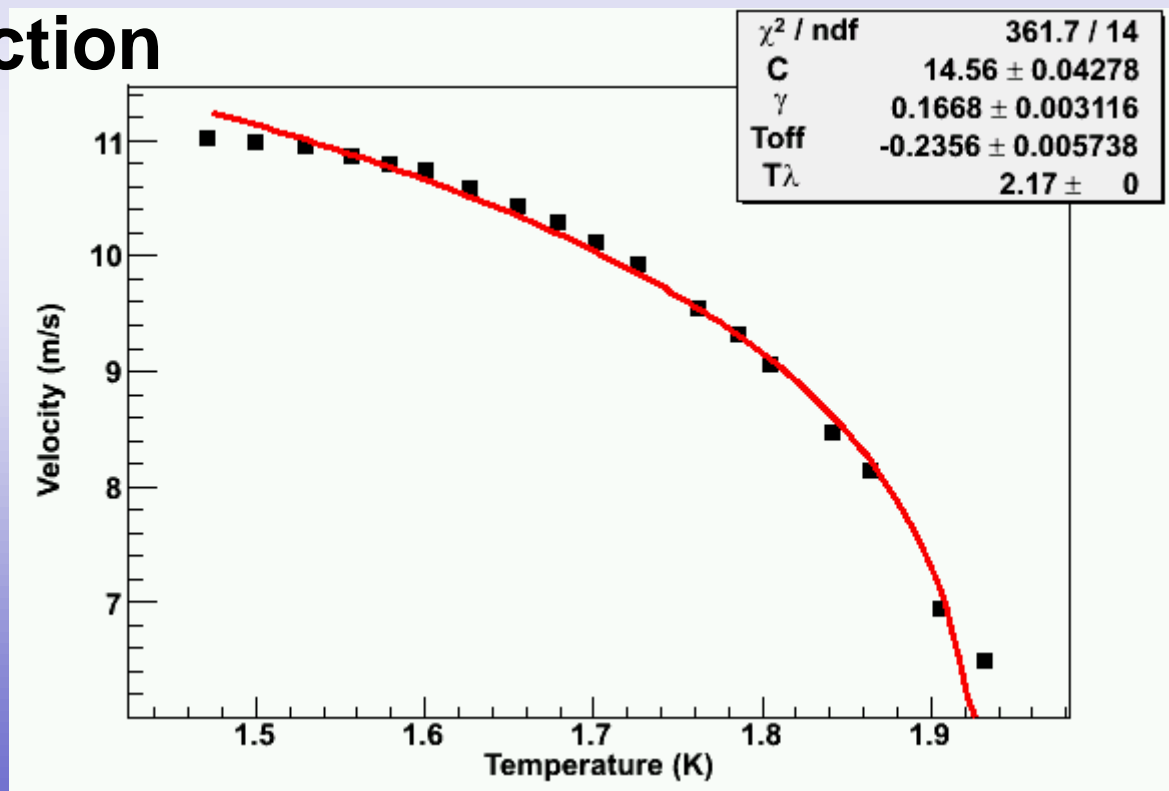

# Finish your talk with the data analysis and conclusions and a slide showing the main points you want us to remember

- ◆ **Make sure you discuss the principal uncertainties.**
  - *For most of these experiments, it will be how accurately does your instrument measure something*
  - *A few experiments will also have statistical uncertainties ... more data leading to a better finding*
- ◆ **Include a representative (simplified) graphic**
  - *This slide will be up during question period so this graphic will get burned into people's memory*
- ◆ **Because this is a lab, offer some advice for others who follow**

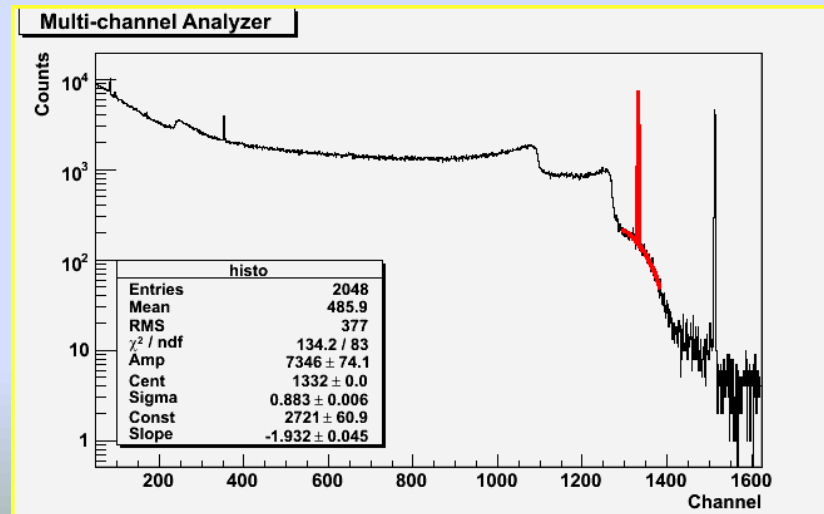

# Typical Problems

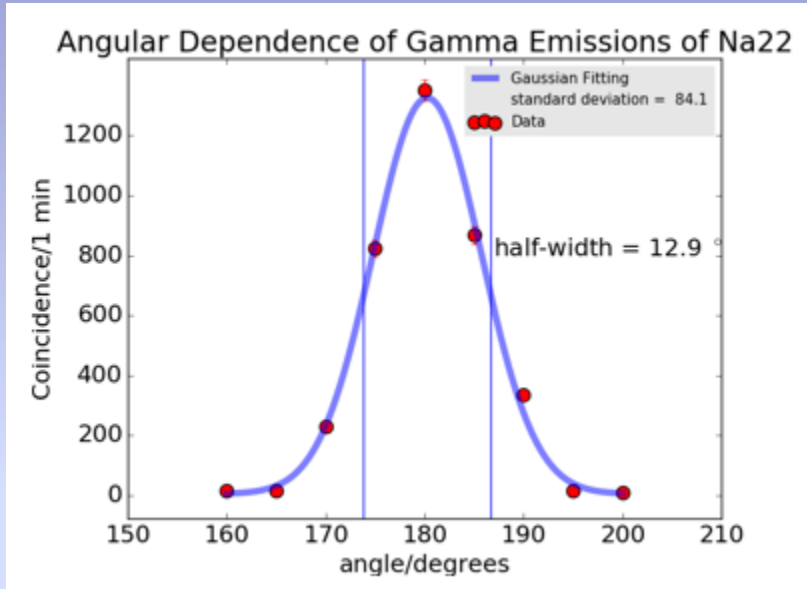

Nice Figure

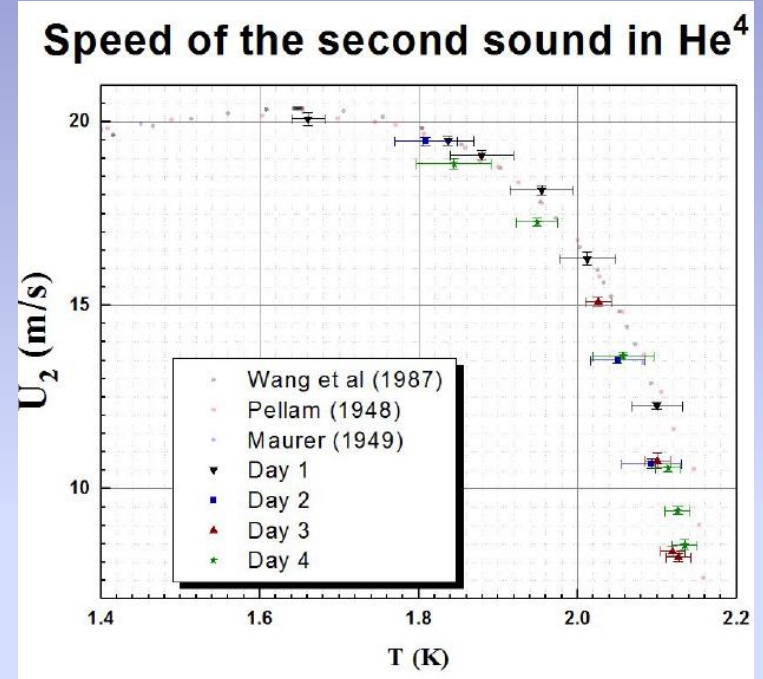

Great Data but lines are too thick and symbols are too small



# Typical Problems

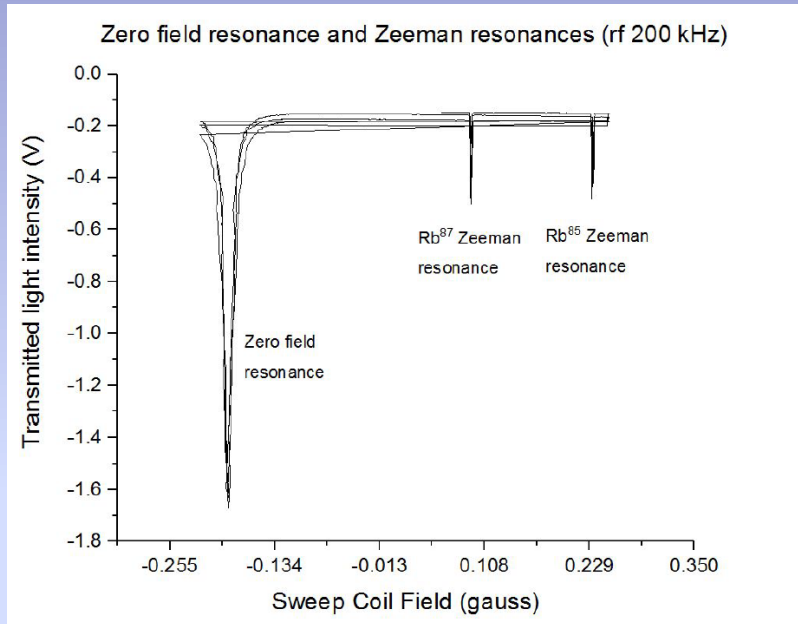

Too many lines –  
graph should be  
“polished”

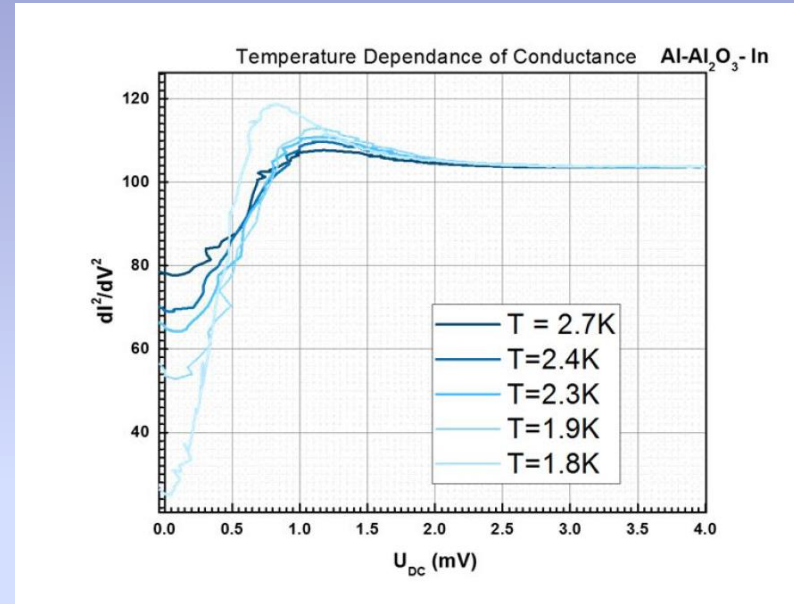

Use more contrast color  
for lines